

# User's Manual

For

## DCS810S

### Digital DC Servo Driver

Revision 1.0

©2009 All Rights Reserved

Attention: Please read this manual carefully before using the driver!



The content in this manual has been carefully prepared and is believed to be accurate, but no responsibility is assumed for inaccuracies.

Leadshine reserves the right to make changes without further notice to any products herein to improve reliability, function or design. Leadshine does not assume any liability arising out of the application or use of any product or circuit described herein; neither does it convey any license under its patent rights of others.

Leadshine's general policy does not recommend the use of its products in life support or aircraft applications wherein a failure or malfunction of the product may directly threaten life or injury. According to Leadshine's terms and conditions of sales, the user of Leadshine's products in life support or aircraft applications assumes all risks of such use and indemnifies Leadshine against all damages.



**Leadshine Technology Co., Ltd.**

3/F, Block 2, Nanyou Tianan Industrial Park, Nanshan Dist, Shenzhen, China

Tel: (86)755-26434369 Fax: (86)755-26402718

URL: [www.leadshine.com](http://www.leadshine.com) E-Mail: [sales@leadshine.com](mailto:sales@leadshine.com)

©2009 by Leadshine Technology Company Limited.

All Rights Reserved

**Table of Contents**

- 1. Introduction, Features and Applications ..... 1
  - Introduction ..... 1
  - Features ..... 1
  - Applications ..... 2
- 2. Specifications and Operating Environment ..... 2
  - Mechanical Specifications ..... 2
  - Elimination of Heat ..... 3
  - Electrical Specifications ..... 3
  - Operating Environment and Parameters ..... 3
- 3. Connections ..... 4
  - Connector Configuration ..... 4
    - General information ..... 4
    - More about +5V, PUL, DIR, ERR/RES Signals ..... 5
    - DIP Switch SW1, SW2 ..... 5
  - Control Signal Connections ..... 6
  - Encoder Connections ..... 6
  - RS232 Interface Connection ..... 7
  - Typical Connections ..... 7
- 4. Servo Setup ..... 8
  - Install Encoder ..... 8
  - Prepare Power Supply ..... 9
    - Regulated or Unregulated Power Supply ..... 9
    - Selecting Supply Voltage ..... 9
  - Prepare Controller ..... 9
  - System Connections and Noise Prevention ..... 10
    - Wire Gauge ..... 10

- Cable Routing ..... 10
- Twisted Wires ..... 10
- Cable Shielding ..... 11
- System Grounding ..... 11
- Power Supply Connection ..... 11
- 5. Tuning the servo ..... 12
  - Testing the servo ..... 12
  - Tuning the Servo ..... 13
- 6. PC window based Tuning Using ProTuner ..... 15
  - Introduction ..... 15
  - Software Installation ..... 15
  - RS232 Interface Connection ..... 20
  - Testing the servo ..... 20
  - Software Introduction ..... 21
    - ProTuner Main Window ..... 21
    - Com Config Window ..... 22
    - Tuning ..... 22
    - Digital\_monitor ..... 28
    - Err\_check ..... 28
    - About ..... 30
  - Servo Tuning ..... 31
    - Position Loop Introduction ..... 31
    - Position around Velocity ..... 31
    - Position around Torque ..... 31
    - Current Loop Tuning Example ..... 32
    - Velocity and Position Loop Tuning ..... 37
- 7. Using Tips ..... 43
  - Sequence Chart of Control Signals ..... 43
  - Protection Functions ..... 43

Over-current Protection .....	44
Over-voltage Protection .....	44
Phase Error Protection.....	44
Encoder Error Protection.....	44
Position Following Error Protection.....	44
Protection Indications.....	45
Changing Default Motor Direction .....	45
Maximum Pulse Input Frequency .....	45
Save data to a file .....	46
Load data from file to Drive.....	47
APPENDIX .....	1
TWELVE MONTH LIMITED WARRANTY .....	1
EXCLUSIONS .....	1
OBTAINING WARRANTY SERVICE .....	1
WARRANTY LIMITATIONS.....	1
SHIPPING FAILED PRODUCT.....	2
Contact Us.....	3

## 1. Introduction, Features and Applications

### Introduction

The DCS810S is a digital DC servo driver developed with DSP and high efficient MOSFET technologies. In position control, it's easy for the end users to change stepping drivers to the DCS810S without changing control systems, because its input command is PUL/DIR signal, which is compatible with that of stepping drivers. In low power motion control applications, performances of DC servo systems using the DCS810S are better than those of digital AC servo systems in velocity, precision, stability, or at least as good as those of digital AC servo systems. However, the cost of the DCS810S stays at the price line of stepping driver, namely far lower than those of AC servo drivers.

The connectors of the DCS810S are specially designed to be compatible with those of the DB810-50V, which have been widely used in inkjet printers. The users can switch to the DCS810S without changing the previous system. Broader input voltage range also makes the DCS810S drive broader range of servo motors than the DB810-50V. What's more, the DCS810S has lower hearing than the DB810-50V owing to its advance digital algorithm. Compared to the DCS810V1, the DCS810S adopts single-ended interface for encoder signals and a extra velocity has been built into it for better performance (The same as DCS810V2).

The DCS810S is very easy to tune and all parameters are visible. PC based and handheld configuration & tuning tools, including Pro Tuner (Windows based setup software) and STU (Small servo tuning unit) can meet different tuning environments or requirements.

### Features

- | 18-80VDC, 0-20A, 20-400W.
- | Based on DSP control technology and high smooth servo control algorithm.
- | PC based and handheld configuration tools, including Pro Tuner and STU.

- | Feedback resolution  $\times 4$  encoder line count.
- | Position Following error lock range adjustable
- | Electronic gear ratio from 1/255 to 255
- | Built-in motion controller for self-test with trapezoidal velocity profile
- | Support PUL/DIR and CW/CCW control signals
- | Opto-isolated inputs, support single-ended signals
- | 10 latest errors self-record function
- | Over-current, over-voltage, under-voltage, phase error, encoder error, position following error protections
- | Small size, surface-mount technology

## Applications

Suitable for a wide range of equipments and instruments such as inkjet printers, mini type engraving machines, and etc. It performs better in applications require low noise, high velocity, high precision and high reliability.

## 2. Specifications and Operating Environment

### Mechanical Specifications (unit: mm[inch])

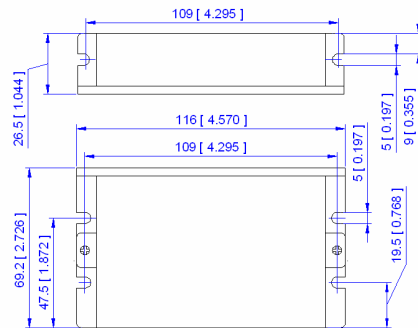

Figure 2-1: Mechanical specifications

## Elimination of Heat

- | Driver's reliable working temperature should be  $< 70^{\circ}\text{C}$  ( $158^{\circ}\text{F}$ ), and motor working temperature should be  $< 80^{\circ}\text{C}$  ( $176^{\circ}\text{F}$ );
- | It is recommended to mount the driver vertically to maximize heat sink area.

## Electrical Specifications ( $T_j = 25^{\circ}\text{C}/77^{\circ}\text{F}$ )

Parameters	DCS810S			
	Min.	Typical	Max.	Unit
Peak output current	0	-	20	A
Supply voltage	+18	-	+80	VDC
Logic signal current	7	10	15	mA
Pulse input frequency	0	-	200	kHz
Isolation resistance	500			MΩ
Current provided to encoder			50	mA

## Operating Environment and Parameters

Cooling	Natural cooling or forced cooling	
Operating Environment	Environment	Avoid dust, oil fog and corrosive gases
	Ambient Temperature	$0^{\circ}\text{C} - 50^{\circ}\text{C}$ ( $32^{\circ}\text{F} - 122^{\circ}\text{F}$ )
	Humidity	40 - 95%RH
	Vibration	$5.9 \text{ m/s}^2$ Max
Storage Temperature	$-20^{\circ}\text{C} - 65^{\circ}\text{C}$ ( $-4^{\circ}\text{F} - 149^{\circ}\text{F}$ )	
Weight	Approx. 210 g (7.4 oz)	

### 3. Connections

#### Connector Configuration

##### General information

Control Signal Connector			
Pin	Signal	Description	I/O
1	+5V	Common +5V power input.	I
2	PUL	Pulse control signal. See more information about PUL in “More about +5V, PUL, DIR, ERR/RES Signals” section.	I
3	DIR	Direction control signal. See more information about DIR in “More about +5V, PUL, DIR, ERR/RES Signals” section.	I
Encoder Signal Connector			
Pin	Signal	Description	I/O
1	EB	Encoder channel B input.	I
2	EA	Encoder channel A input.	I
3	E +5V	Positive pole of the auxiliary power supply (50 mA Max ).	O
4	EGND	Ground of the auxiliary power supply.	GND
5	ERR/RES	Alarm signal output (+5V) or reset signal input (+5V).	O
Power Connector			
Pin	Signal	Description	I/O
1	Motor+	Motor positive connection.	O
2	Motor-	Motor negative connection.	O
3	+VDC	+18 TO 80VDC power input.	I
4	GND	Power ground.	GND
RS232 Communication Connector			
Pin	Signal	Description	I/O
1	NC	Not connected.	-
2	+5V	+5V power for STU only.	O
3	TxD	RS232 transmit.	O
4	GND	Ground.	GND
5	RxD	RS232 receive.	I
6	NC	Not connected.	-

#### More about +5V, PUL, DIR, ERR/RES Signals

Pin Function	Details
+5V	+5V Opto-coupler power supply.
PUL	<u>Pulse signal</u> : In single pulse (pulse/direction) mode, this input represents pulse signal, each rising or falling edge active (software configurable); 4-5V when PUL-HIGH, 0-0.5V when PUL-LOW. In double pulse mode (pulse/pulse) , this input represents clockwise (CW) pulse, active both at high level and low level (fixed level software configurable). For reliable response, pulse width should be longer than 2.5μs. Series connect resistors for current-limiting when +12V or +24V used. The same as DIR and ENA signals.
DIR	<u>DIR signal</u> : In single-pulse mode, this signal has low/high voltage levels, representing two directions of motor rotation; in double-pulse mode (software configurable), this signal is counter-clock (CCW) pulse, active both at high level and low level (fixed level software configurable). For reliable motion response, DIR signal should be ahead of PUL signal by 5μs at least. 4-5V when DIR-HIGH, 0-0.5V when DIR-LOW. Please note that rotation direction is also related to motor-driver wiring match. Exchanging the connections of two wires of the motor to the driver and A/B phase signals of encoder will reverse motion direction.
ERR/RES	<u>ERR/RES Pin</u> : Used to output error and reset the DCS810S to clear errors. +5 VDC when driver is normal. If protection functions such as over-voltage, over-current, phase error, encoder error, position following error are activated, ERR/RES pin will be pulled to LOW level (EGND). <b>Only</b> Position Following Error can be cleared by connecting the E+5V to ERR/RES, and the users should repower the driver to clear other errors after removing other related problem(s).

#### DIP Switch SW1, SW2

There are two DIP switches (SW1 and SW2) can be used to select 4 group servo parameters stored in EEPROM of the driver. The user can select one group of these servo parameters to optimize the performance for different applications, in which using different motors or having different load. For most applications, these two DIP switches should be both on OFF position (Factory Default Status), saving/selecting

the user's own servo parameters, NOT other 3 group for dedicated applications.

### Control Signal Connections

The DCS810S has 2 optically isolated logic inputs to accept PUL/DIR control signals. These inputs are isolated to minimize or eliminate electrical noises coupled onto the control signals. In the following figure, connections to open-collector control signals are illustrated.

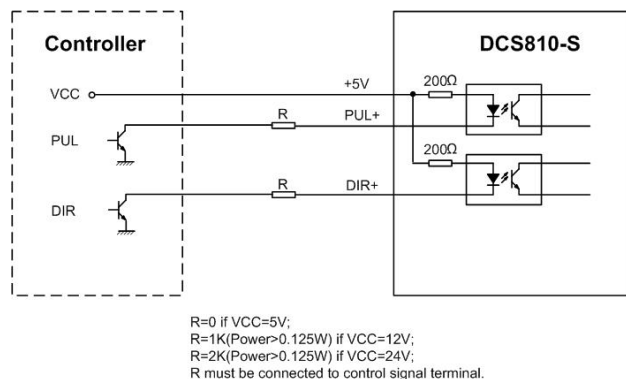

Figure 3-1: Connections to open-collector control signal (common-anode)

### Encoder Connections

The DCS810S can accept encoder input from single-ended incremental encoders. Note that twisted-pair shielded cabling provides the best immunity in electrically noisy environments.

If the encoder drains less than 50mA, the DCS810S can supply the encoder directly, and connect it as Figure 3-2. If the encoder drains more than 50mA, use an external DC supply and connect it as Figure 3-3.

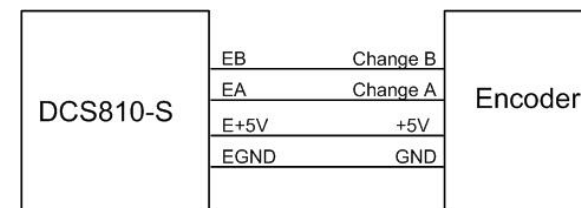

Figure 3-2: The DCS810S supplies the single-ended encoder directly

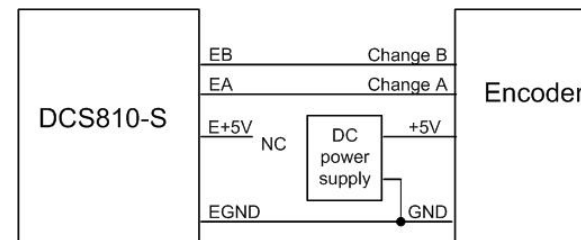

Figure 3-3: Using external DC power supply to supply the encoder

### RS232 Interface Connection

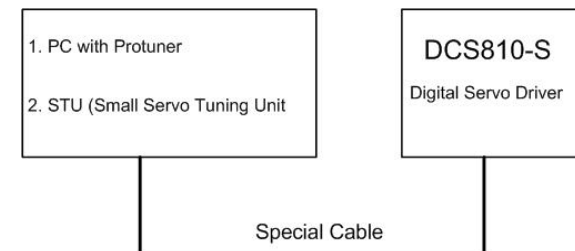

Figure 3-4: RS232 interface connection

### Typical Connections

Typical connections of the DCS810S are shown as Figure 3-5. Please consult “Control Signal Connections” and “Encoder Connections” for more information about controller and encoder connections.

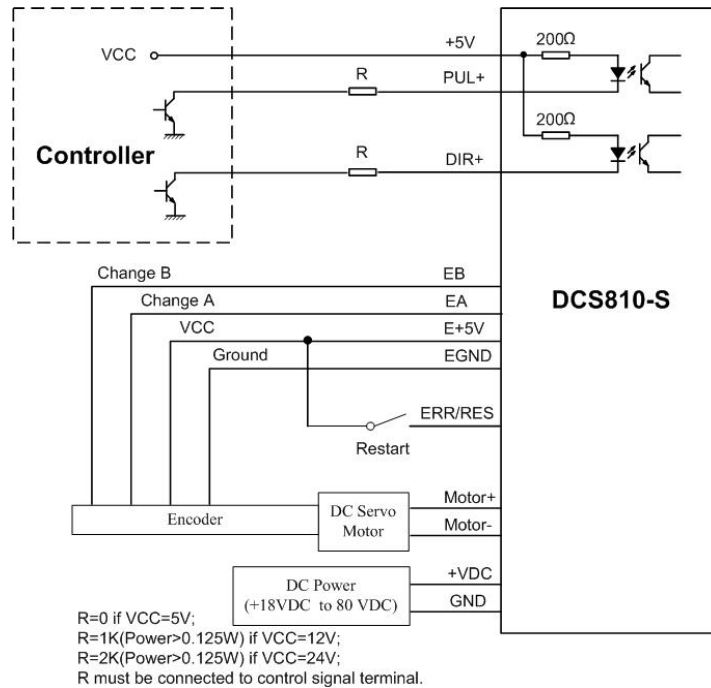

Figure 3-5: Typical connection (Open-collector control signal and single-ended encoder.)

## 4. Servo Setup

Before you start the servo, you can follow the below steps.

### Install Encoder

If your motor has no encoder, you must have an encoder (more than 200 lines) properly mounted on the motor before you start. And please assemble the encoder according to its factory manual. Please use shielded cables and separate encoder signal cable from interference sources, such as motor wires and power wires at least 5 cm.

## Prepare Power Supply

### Regulated or Unregulated Power Supply

Both regulated and unregulated power supplies can be used to supply the driver. However, unregulated power supplies are preferred due to their ability to withstand current surge. If regulated power supplies (such as most switching supplies.) are indeed used, it is important to have large current output rating to avoid problems like current clamp, for example using 4A supply for 3A motor-driver operation. On the other hand, if unregulated supply is used, one may use a power supply of lower current rating than that of motor (typically 50% ~70% of motor current). The reason is that the driver draws current from the power supply capacitor of the unregulated supply only during the ON duration of the PWM cycle, but not during the OFF duration. Therefore, the average current withdrawn from power supply is considerably less than motor current. For example, two 3A motors can be well supplied by one power supply of 4A rating.

### Selecting Supply Voltage

The DCS810S can actually operate within +18V to +80VDC, including power input fluctuation and back EMF voltage generated by motor coils during motor shaft deceleration. The rated voltage of the motor is an important parameter when selecting supply voltage. Generally speaking, do not use a power supply voltage more than 5 volts of the rated voltage of the motor. Higher voltage may cause bigger motor vibration at lower speed, and it may also cause over-voltage protection or even driver damage.

### Prepare Controller

Prepare a controller with pulse and direction signals. However, the DCS810S has a built-in motion controller for self-test and Servo Tuning. The built-in motion controller can generate control signal with trapezoidal velocity profile.



## System Connections and Noise Prevention

After finishing the above steps, you can connect your servo system. Before you start, make sure that the power is off. Connect your system according to connection diagrams before, and pay attention to the following tips when wiring.

### Wire Gauge

The smaller wire diameter (lower gauge), the higher impedance. Higher impedance wire will broadcast more noise than lower impedance wire. Therefore, when selecting the wire gauge, it is preferable to select lower gauge (i.e. larger diameter) wire. This recommendation becomes more critical as the cable length increases. Use the following table to select the appropriate wire size to use in your application.

Current (A)	Minimum wire size (AWG)
10	#20
15	#18
20	#16

### Cable Routing

All content sensitive signal wires should be routed as far away from motor power wires and driver power wires as possible. Motor power and driver power wires are major sources of noise and can easily corrupt a nearby signal. This issue becomes increasingly important with longer motor power and driver power wires lengths.

### Twisted Wires

Twisted wires effectively increasing noise immunity. The successive twists eliminate noise transients along the length of the cable. Both signal cables and power cables should be of the twisted and shielded type. Differential signal wires should be twisted as a pair. The combination of twisted pair wires and a differential signal significantly adds to noise immunity. Power wires should be twisted as a group

along with the ground (or chassis) wire, if available.

### Cable Shielding

All signal wires should be bundled and shielded separately from driver power and motor power wires. Power wires should also be bundled and shielded. When grounding a shield, the rule-of-thumb is to do so at the ‘source’ of power while leaving the other shield end open. For example, in the case of motor power wires, this would be the drive side. Ideally, twisted pairs should be individually shielded and isolated from the outer shield, which encompasses all wires within the cable. However, since this type of stringent shielding practice is often not required, typical cables do not provide isolation between inner and outer shields.

### System Grounding

Good grounding practices help reduce the majority of noise present in a system. All common grounds within an isolated system should be tied to PE (protective earth) through a ‘SINGLE’ low resistance point. Avoiding repetitive links to PE creating ground loops, which are a frequent source of noise. Central point grounding should also be applied to cable shielding; shields should be open on one end and grounded on the other. Close attention should also be given to chassis wires. For example, motors are typically supplied with a chassis wire. If this chassis wire is connected to PE, but the motor chassis itself is attached to the machine frame, which is also connected to PE, a ground loop will be created. Wires used for grounding should be of a heavy gauge and as short as possible. Unused wiring should also be grounded when safe to do so since wires left floating can act as large antennas, which contribute to EMI.

### Power Supply Connection

**NEVER** connect power and ground in the wrong direction, because it will damage the DCS810S driver. The distance between the DC power supply of the drive and



the drive itself should be as short as possible since the cable between the two is a source of noise. When the power supply lines are longer than 50 cm, a 1000 $\mu$ F/100V electrolytic capacitor should be connected between the terminal “GND” and the terminal “+VDC”. This capacitor stabilizes the voltage supplied to the drive as well as filters noise on the power supply line. Please note that the polarity can not be reversed.

It is recommended to have multiple drivers to share one power supply to reduce cost if the supply has enough capacity. To avoid cross interference, **DO NOT** daisy-chain the power supply input pins of the drivers. Instead, please connect them to power supply separately.

## 5. Tuning the servo

### Testing the servo

You may wish to secure the motor so it can't jump off the bench. Turn on the power supply, the green (Power) LED will light. The DCS810S has default parameters stored in the driver. If the system has no hardware and wirings problem, the motor should be locked and the driver should be ready.

If the motor jumps slightly and the red LED immediately turns on (flickers), then either the motor or the encoder is wired in reversal. Open the tuning software ProTuner and check driver status by clicking **Err\_check**. If it's **Phase Error**, then reversal motor wires or exchange encoder inputs and try again. If it's **Encoder Error**, please check encoder and its wirings, and then try again. If it still doesn't work after you followed all of the previous steps, please contact us at [tech@leadshine.com](mailto:tech@leadshine.com).

If the red LED is off and the motor is normal, then you can start to tune the servo with selected tool. **ProTuner**, and **STU** are available for the DCS810S.

## Tuning the Servo

A servo system is error-driven. The “Gain” of the system determines how hard the servo tries to reduce the error. A high-gain system can produce large correcting torques when the error is very small. A high gain is required if the output is required to follow the input faithfully with minimal error.

A servo motor and its load both have inertia, which the servo amplifier must accelerate and decelerate while attempting to follow a change at the input. The presence of the inertia will tend to result in over-correction, with the system oscillating beyond either side of its target. It's called UNDER DAMPED status. See Figure 5-1. This oscillation must be damped, but too much damping will cause the response to be sluggish, namely cause the system to get into an OVER DAMPED state. When we tune a servo, we are trying to achieve the fastest response with little or no overshoot, namely get a CRITICALLY DAMPED response.

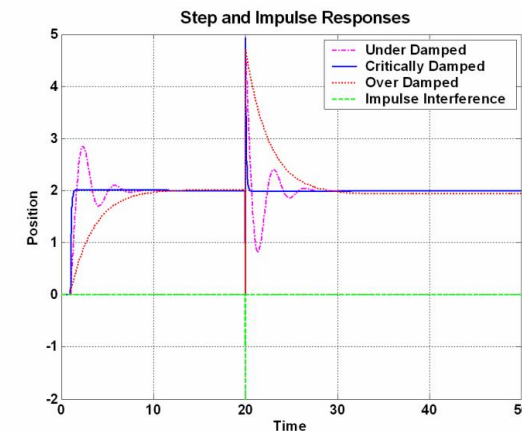

Figure 5-1: Step and impulse responses

As mentioned in previous contents, the DCS810S is a digital servo driver and its input command is PUL/DIR signal. In other words, step response just exists in each

step command signal. For each step command signal is a very small movement, so OVER SHOOT and SETTLING TIME between each step are very small, causing you hardly can see a step response such as Figure 13, even if the SET POINT is a very large quantity and the acceleration is very high.

However, if you try to evaluate performances of the digital servo by investigating its position tracking-error or position following error, you may find it's much easier than investigating its step response. The easiest way to get a tracking-error or position following error response is to induce an impulse load on the motor. See Figure 5-1 at "time 20".

Leadshine offer a Windows based setup software **ProTuner** and a Small servo tuning unit **STU** (optional) to its customers for evaluating servo performances. **STU** is for field tuning without PC.

Tuning servo systems formed by DCS810S drivers can be summarized as the following rules:

1. If servo system is UNSTABLE, then the first thing of tuning is to stabilize the system. You can increase **Derivative Gain** of **Position Loop** (Kd) or decrease **Proportional Gain** of Position Loop (Kp) or **Integral Gain** of Position Loop (Ki).
2. If servo system is UNDER DAMPED, then increase Kd or decrease Kp or Ki.
3. If servo system is CRITICALLY DAMPED, then stop tuning and download the parameter settings to the driver's EEPROM.
4. If servo system is OVER DAMPED, then decrease Kd or increase Kp or Ki.

## 6. PC window based Tuning Using ProTuner

### Introduction

This manual will provide an overview of connection and basic setup instructions for Leadshine's digital servo driver DCS810S using the **ProTuner** software. The basic setup of a digital driver is designed to be analogous to the setup and tuning of an analog amplifier. These instructions will walk you through the following steps necessary to start up your driver and motor. This document is intended for setting up the driver with the **ProTuner**.

### Software Installation

The ProTuner is windows based setup software for tuning Leadshine's digital drivers. It can run in windows systems, including Win95/Win98/WindowsNT/ Windows 2000/Windows XP. And the selected PC should have 1 serial port at least for communicating with the driver.

Double click "**ProTuner\_All\_Setup\_V1.0.exe**" to begin installing the **ProTuner**. See Figure 6-1. Click **Next** to enter the "License Agreement" window. See Figure 6-2.

**Note:** **ProTuner\_All\_Setup\_V1.0.exe** can be used for all Leadshine digital drives. User can get it from either Leadshine CD or website. Please get the latest version from <http://www.leadshine.com>.

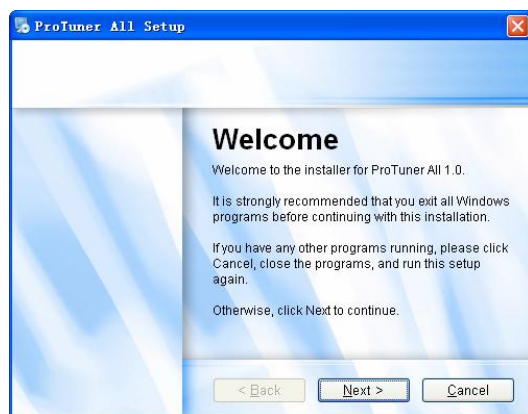

Figure 6-1: Begin to install the ProTuner



Figure 6-2: License agreement

Choose “I agree to the terms of this license agreement” and click **Next** to continue installation. The user can enter user’s information in the following window. See Figure 6-3. After entering the user’s information, click **Next** to select installation folder, where you would like to install the **ProTuner**. See Figure 6-4.

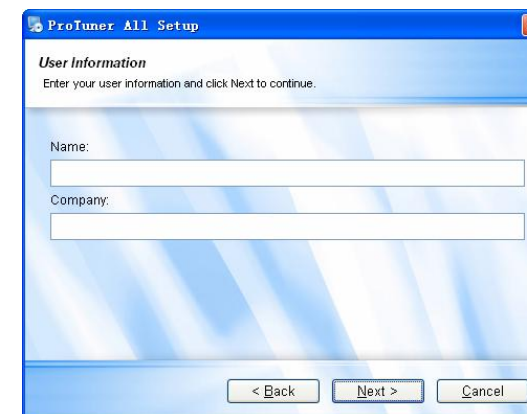

Figure 6-3: User’s information settings

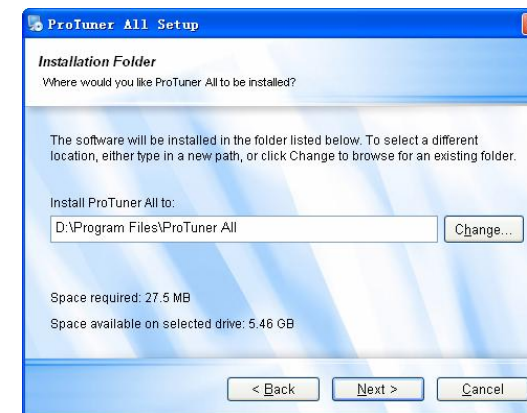

Figure 6-4: Installation folder settings

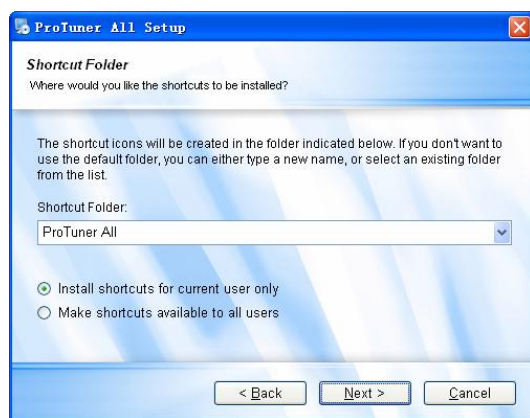

Figure 6-5: Shortcut folder setting

Set the “Shortcut Folder” in Figure 6-5 and continue to install the **ProTuner** by following Figure 6-6 and Figure 6-7. An **Installation Successful** window will appear if the **ProTuner** is installed successfully. See Figure 6-8.

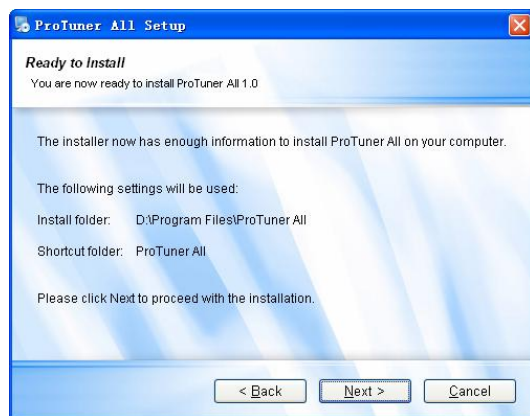

Figure 6-6: Installation information summarization

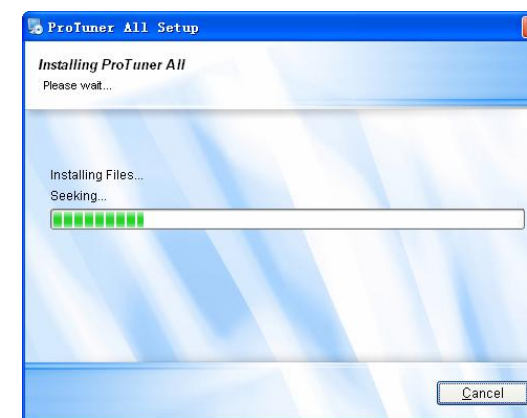

Figure 6-7: Installing the ProTuner

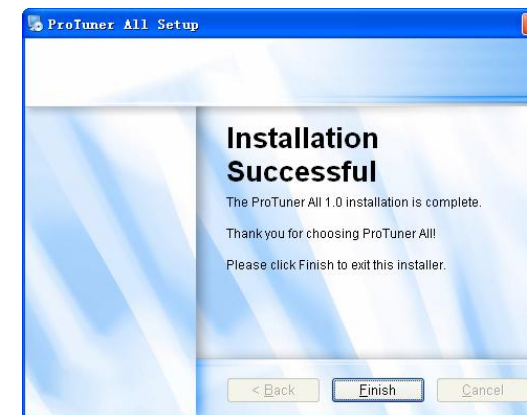

Figure 6-8: Finish installation

**Note:** Please visit our website [www.leadshine.com](http://www.leadshine.com) for latest ProTuner. DCS810S use the same software as DCS810S. Please select **ProTuner DCS810V2** in the start menu.

### RS232 Interface Connection

Connect the servo system according to chapter “Connections” and connect the PC to the driver as the following figure.

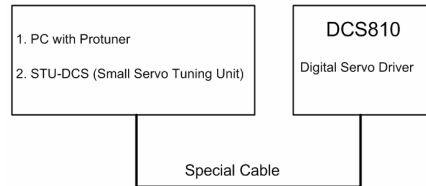

Figure 6-9: RS232 interface connection

### Testing the servo

You may wish to secure the motor so it can't jump off the bench. Turn on the power supply, the green (Power) LED will light. The DCS810S has default parameters stored in the driver. If the system has no hardware and wirings problem, the motor should be locked and the driver should be ready.

If the motor jumps slightly and the red LED immediately turns on (flickers), then either the motor or the encoder is wired in reversal. Open the tuning software ProTuner and check driver status by clicking **Err\_check**. If it's **Phase Error**, then reversal motor wires or exchange encoder inputs and try again. If it's **Encoder Error**, please check encoder and its wirings, and then try again. If it still doesn't work after you followed all of the previous steps, please contact us at [tech@leadshine.com](mailto:tech@leadshine.com).

If the red LED is off and the motor is normal, then you can start to tune the servo with **ProTuner**. However, we recommend you see the following contents before starting tuning.

### Software Introduction

DCS810S use the same software as DCS810S. Please select **ProTuner DCS810V2** in the start menu to open ProTuner.

### ProTuner Main Window



Figure 6-10: ProTuner

### Ø Option

The user can choose three drop-down menus by clicking “**Option**”, including **Com Config**, **SaveToDriver**, **Archives** and **Exit**.

- l **Com Config**: Configure Com communication interface.
- l **SaveToDriver**: Download the current parameter settings to the driver.
- l **Archives**: Save the current parameter to a file or read parameter from a file.



I **Exit:** Exit the **ProTuner**.

**Com Config Window**



Figure 6-11: RS232 communication configuration window

**Serial Port:** Select the serial communication port to which the driver is connected. The factory default setting is COM1.

**Baud Rate:** Select the communication baud rate. The factory default setting is 38400.

Click **Open** button to establish a connection with the specified settings. When connecting, you can choose **SaveToDrive** to download the current parameter settings to the driver, or to upload the stored driver settings into the **ProTuner** by clicking **Tuning > Position Loop** on the menu bar.

**Tuning**

The user can choose one or two drop-down menu(s) by clicking **Tuning**, including **CurrentLoop** and **PositionLoop**.

I **CurrentLoop:** It is used to configure current loop parameters according to different motor. In the tuning window, User can set **Kd**, **Ki** and **I-test**.

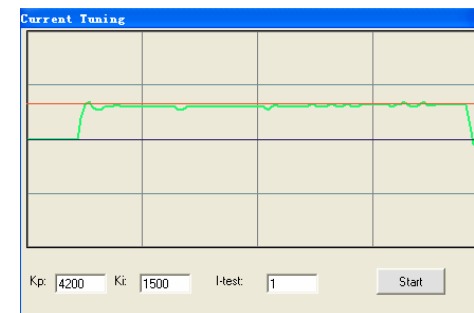

**Kp:** Current Proportional gain. Increase this parameter to make current rise fast.

**Ki:** Current Integral gain. Adjust this parameter to reduce the steady error.

**I-test:** The current amplitude for the step response.

**Start** button: Click to activate the test. A target curve and a actual curve will display on the screen for user analysis.

I **PositionLoop:** There are three tabs in **Position Loop Tuning** window, including **P\_parameter**, **T\_Speed\_Par**, and **CurveSetting** tabs.

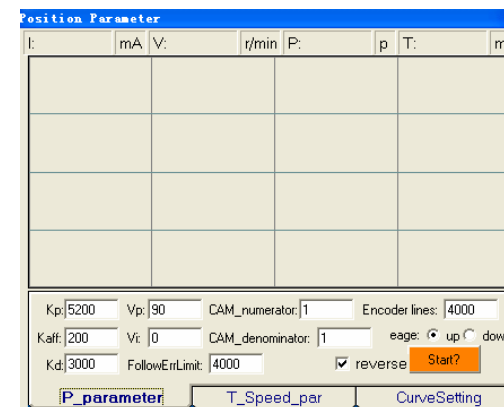

Figure 6-12: P\_parameter tab



In **P\_parameter** tab, the user can set **Position Loop** PID parameters, **Electronic Gear Ratio**, **Position Following Error Limit**, etc.

**Kp: Position Proportional Gain.** Proportional Gain determines the response of the system to position errors. Low Proportional Gain provides a stable system (doesn't oscillate), has low stiffness, and large position errors under load. Too large Proportional Gain values will cause oscillations and unstable systems.

**Kaff: Position Acceleration feed-forward gain.** It is used to adjust the position following error during acceleration and deceleration.

**Kd: Position Derivative Gain.** Derivative Gain provides damping by adjusting the output value as a function of the rate of change of error. A low value provides very little damping, which may cause overshoot after a step change in position. Large values have slower step response but may allow higher Proportional Gain to be used without oscillation.

**Vp: Velocity Proportional Gain.** It is similar as Kd but for velocity loop.

**Vi: Velocity Integral Gain.** It is used to adjust the steady velocity error when the velocity is stable.

**CAM\_numerator: Numerator of Electronic Gear.** Can be set from 1 to 255.

**CAM\_denominator: Denominator of Electronic Gear.** Can be set from 1 to 255.

**Position FollowErrLimit: Position Following Error Limit.** The limit of the difference between commanded position and the actual measured position. When position following error reaches Position Following Error Limit parameter setting in the driver, the protection will be activated.

**Encoder Lines: Encoder Line Count.** The DCS810S supports single-ended and differential-ended incremental encoders. Here, one thing should explained is that the

Encoder Lines parameter in this tab is just for self-test motion controller during tuning, and will not affect the driver to interpret the encoder feedback signal. With regard to the DCS810S, feedback resolution is  $\times 4$  encoder line count.

**edge: Active Edge.** The user can set the triggered edge of pulse command signal in this panel. **Up** means up-rise edge and **Down** means falling edge. When the driver works in CW/CCW mode, no matter what level is at fixed level terminal, the driver can works properly.

**reverse: Reverse Direction :** Change the default direction to the same input level in DIR. For example, the motor run CW at default setting and will run CCW if **reverse** is selected.

**Start/Stop** button: The user can start or stop self-test by clicking this button.

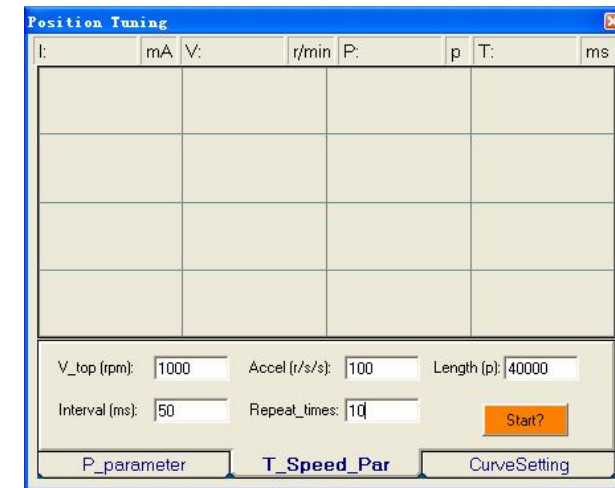

Figure 6-13: T\_Speed\_Par tab

In **T\_Speed\_Par** tab, the user can set velocity profile for self motion test and tuning, including Maximum Speed, Acceleration, position move Distance of trapezoidal

velocity profile, and Interval, Repeat Times of self motion test.

**V\_top: Maximum Speed.** The maximum speed of trapezoidal velocity profile. Its unit is RPM.

**Accel: Acceleration.** The acceleration of trapezoidal velocity profile. Its unit is (r/s)/s.

**Length: Distance.** The distance required to move. Its unit is pulse (count).

**Interval:** The interval between positive rotation and negative movement.

**Repeat\_times:** The repeat times of positive and negative movement.

**Start/Stop button:** The user can start or stop self-test by clicking this button.

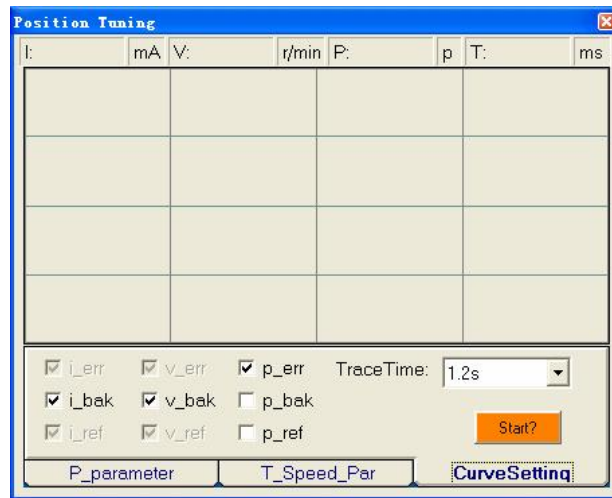

Figure 6-14: CurveSetting tab

In **CurveSetting** tab, the user can choose curves displayed in digital scope of **Position Loop Tuning** window and **DigitalMonitor** window, and set their **Trace Time**. These curves includes **Current Following Error** (i\_err), **Velocity Following**

**Error** (v\_err), **Position Following Error** (p\_err), **Current Feedback** (i\_bak), **Velocity Feedback** (v\_bak), **Position Feedback** (p\_bak), **Current Command** (i\_ref), **Velocity Command** (v\_ref), **Position Command** (p\_ref).

**i\_err: Current Following Error.** The difference between commanded current and the actual measured current.

**v\_err: Velocity Following Error.** The difference between commanded velocity and the actual measured velocity.

**p\_err: Position Following Error.** The difference between commanded position and the actual measured position.

**i\_bak: Current Feedback.** This is the actual measured current in motor coil. Ideally, this value should be as close as possible to the commanded current.

**v\_bak: Velocity Feedback.** This is the actual measured velocity measured by the encoder. Ideally, this value should be as close as possible to the commanded velocity.

**p\_bak: Position Feedback.** This is the actual measured position measured by the encoder. Ideally, this value should be as close as possible to the commanded position.

**i\_ref: Current Command.** This is the commanded current.

**v\_ref: Velocity Command.** This is the commanded velocity.

**p\_ref: Position Command.** This is the commanded position.

**Trace Time: Trace Time.** This is the trace time of the digital scope.

**Start/Stop button:** The user can start or stop self-test by clicking this button.

**Digital\_monitor**

**I Digital Monitor:** Displays curves and dynamic values of different point of different curves.



Figure 6-15: Digital scope window

**I: Current.** Displays dynamic values for Current related curve(s). Dynamic value will change with mouse focus changes. Its unit is mA.

**V: Velocity.** Displays dynamic values for Velocity related curve(s). Dynamic value will change with mouse focus changes. Its unit is r/min.

**P: Position.** Displays dynamic values for Position related curve(s). Dynamic value will change with mouse focus changes. Its unit is pulse (count).

**T: Time.** Displays dynamic values for Time. Dynamic value will change with mouse focus changes. Its unit is ms.

**Err\_check**

**I Error Check:** This window shows both the present status of each error event and their history. Current error event(s) can be reset by clicking **Erase Current Err!** button, and all error events can be reset by clicking **Erase All!** button.

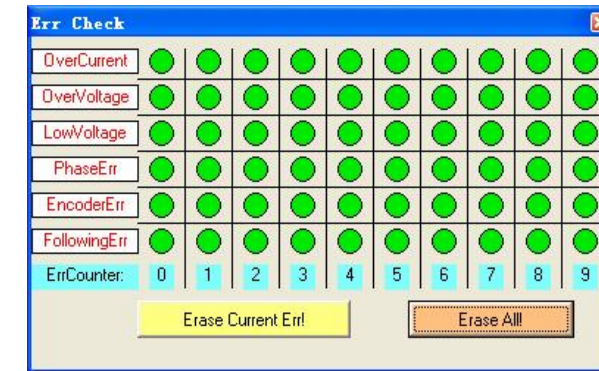

Figure 6-16: Error check window

**OverCurrent: Over-current Protection.** Protection will be activated when continuous current exceeds 20A.

**OverVoltage: Over-voltage Protection.** When power supply voltage exceeds 36.5 ± 1.5 VDC, protection will be activated.

**PhaseErr: Phase Error Protection.** Motor power lines wrong & not connected and encoder feedback signals A/B phases wrong connected will activate this protection.

**EncoderErr: Encoder Error Protection.** No encoder feedback signals or wrong encoder feedback signals will activate this protection.

**FollowingErr: Position Following Error Limit Protection.** When position following error reaches **Position Following Error Limit** parameter setting in the driver, this protection will be activated.

**ErrCounter:** Displays current error(s) and current error history.

**Erase Current Err!:** **Erase Current Err** button. The user can clear current error(s) by clicking this button.

**Erase All!:** **Erase All!** button. The user can clear all error(s) including error history

by clicking this button.

## About

The user can choose two drop-down menus by clicking “**About**”, including **Product Information** and **Contact Us**.

- I **Product Information** window: Shows some product information about ProTuner.
- I **Contact Us** window: Shows some contact information about Leadshine.



Figure 6-17: Product information

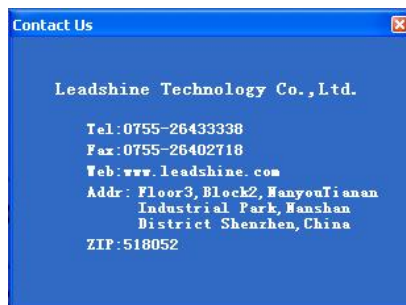

Figure 6-18: Contact information

## Servo Tuning

### Position Loop Introduction

Position loop tuning is dependant on the mechanical load, and therefore will change with any mechanical system changes. Position loop tuning should be performed with the motor installed in the system. The position loop can be closed around velocity or torque mode (depending on whether the velocity loop is enabled or disabled). If it is closed around velocity mode, the position loop algorithm output becomes the new velocity set point. If it is closed around torque mode, the position loop algorithm output becomes the new torque set point. There are some important differences in the tuning process and application of these two approaches:

**Position around Velocity:** This mode is most common in "contouring" application, where a position trajectory must be tracked very closely. The velocity loop provides additional "stiffness", and keeps the dynamic position errors minimal, since the system now reacts to not just position errors, but also velocity errors (which can be interpreted as position error changes). It is important to start with a stable yet responsive velocity loop. Typically, it is sufficient to just use the position loop proportional gain. Feed-forward gain can be added to improve tracking performance (i.e. minimize the difference between commanded and actual position). The velocity loop is disabled in current version DCS810S, and it adopts **Position around Current** (Torque) mode.

**Position around Torque:** This mode is most common in point-to-point applications, where actual motion between start and end point is not very critical. In this case, velocity loop tuning can be avoided. This can be advantageous if the velocity feedback is poor (e.g. low resolution encoder, poor encoder quadrature.). **In this case, the tuning process requires that the position loop proportional and derivative gain are increased simultaneously, unless the system has sufficient friction, in which case no derivative gain is necessary. Once a stable response is**

**achieved, integral gain can be added to improve stiffness.** It is best to use a step command with the profiler enabled as a reference signal during tuning.

Driver tuning is a multi-step process that involves proper tuning of up to three different servo loops, namely current loop, velocity loop and position loop. You can either tune the position loop around the velocity loop, or around the current loop. Generally, it is much easier to tune a position loop around a velocity loop because only the proportional gain is needed. When tuning position around the current loop, a high derivative gain may be necessary on top of both proportional and integral gains.

For most of the DCS810S drivers have been being sold to the customers with Leadshine’s DCM5xxxx DC servo motors, Leadshine will tune the current loop before sending drivers out of the factory. Most of customers just need to tune the position loop parameters with the standard version if they use the drivers with Leadshine’s DCM5xxxx DC servo motors. If you use the DCS810S with DC servo motors from other manufacturers and current loop tuning is needed. Please use ProTuner to tune the current loop at first.

Follow the steps below for tuning the driver with the **ProTuner**.

### Current Loop Tuning Example

If user uses Leadshine DCM series motor, they don’t need to tune the current loop parameter. But if other brand motor is selected, please contact Leadshine for the password for current loop tuning. Below is an example to show the tuning procedure of current loop based on Leadshine DCM50207D-1000. See Figure 6-19 for connection information and other necessary component.

(DCM50207D-1000 specification:

0.35Nm@2900RPM, Phase resistance=0.9Ohm

Phase Inductance=1.6mH, Encoder Lines = 1000)

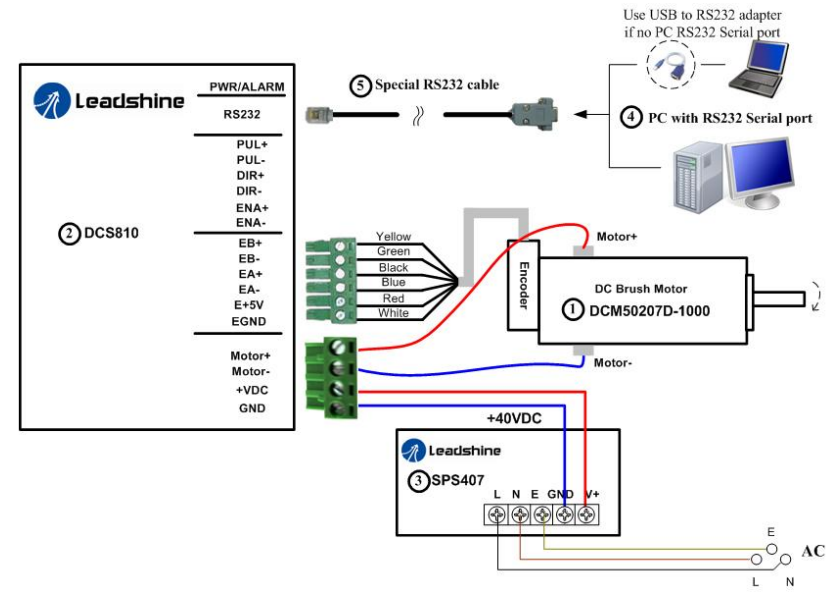

Figure 6-19: Connections in tuning example

**Step 1:** See figure 6-20. Set **I-test** 1 and begin the tuning with small **Kp** and zero **Ki**. Here we give **Kp** 500. Please hit the “Enter” key after entering in the number.

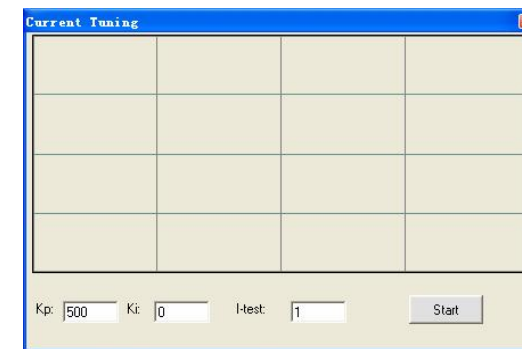

Figure 6-20: Initial value for Kp, Ki and I-test for current loop tuning



**Step 2:** Click the **Start** button and the plot window will show two curves. The red one is target current and the green one is actual current. There is large gap between them in the scope. It indicates that a large **Kp** need to be introduced. See figure 6-21.

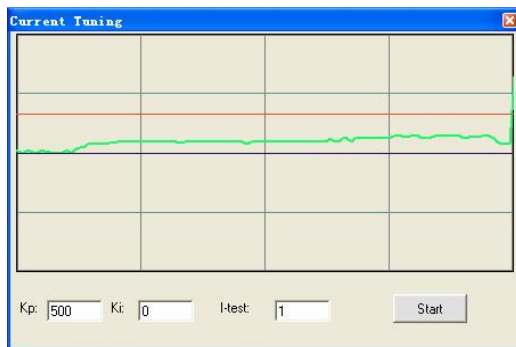

Figure 6-21: Current loop tuning with  $K_p=500$ ,  $K_i=0$

**Step 3:** Increase **Kp** to 1000 and click **Start**. The gap between target value and actual value is smaller but a higher **Kp** is needed. See figure 6-22.

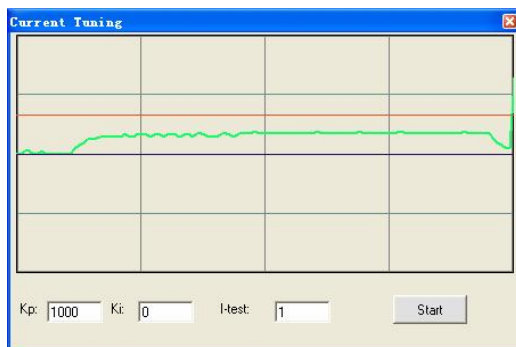

Figure 6-22: Current loop tuning with with  $K_p=1000$ ,  $K_i=0$

**Step 3:** Give **Kp** 2000, 3000, 4000, 5000 and click **Start**, respectively. The green curve is getting more and more close to the red curve. See figure 6-23. Over-shoot begins when we increase **Kp** to 5000. It indicates that you need to stop increasing

**Kp** and back off. Our purpose is to make the green curve (the actual current) a little higher than the red curve (the target). So we decrease **Kp** to 4500, 4200 and until the actual value is exactly over the target value.

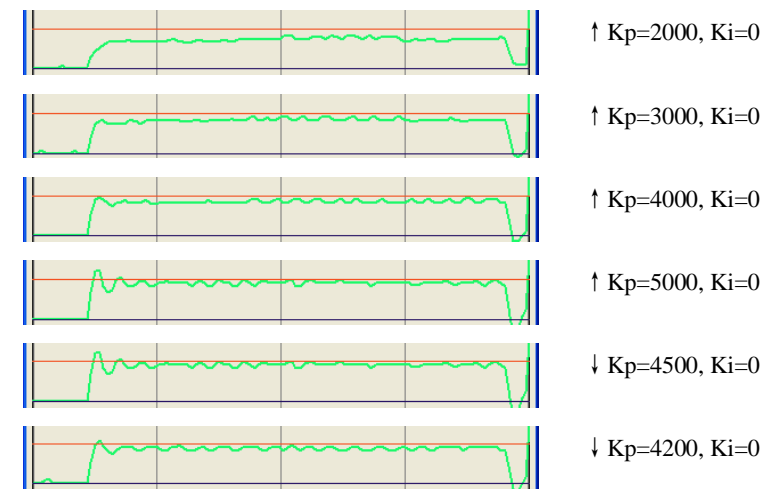

Figure 6-23: Current loop tuning with with  $K_i=0$  and increasing  $K_p$

**Step 4:** Now **Kp** is relative good enough. But there is still gap between the green curve and the red curve when we use the mouse to zoom in it as shown in figure 6-24. There is also big vibration, which will cause motor noise, on the green curve. So we need to introduce **Ki**, the integral gain to reduce the “gap” or steady error at the constant part. It follows the same procedure as **Kp**. Too high **Ki** will causes big vibration, system lag and makes the performance worse. See figure 6-24 for this procedure. Increase **Ki** until the gap can be accepted and not causes much vibration.

**Step 5:** The current loop tuning is basically finished. You can continue to adjust **Kp** and **Ki** for better performance. Now the updated **Kp** and **Ki** is just stored in the driver’s RAM. They will be lost when we power off the driver. **Please click Option->SaveToDriver to store the changed value to the driver’s EEPROM.**



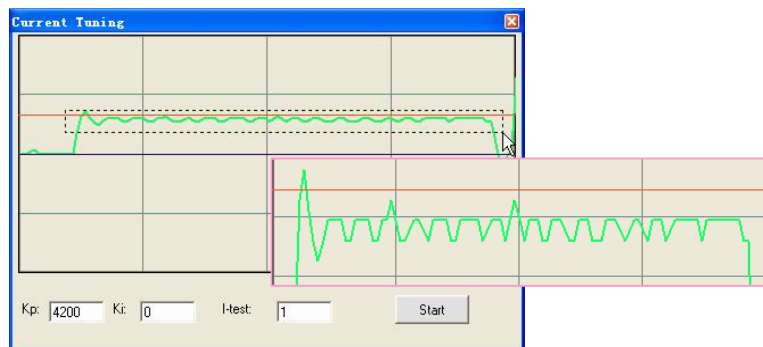

Figure 6-23: Drag a rectangle to zoom in the steady error

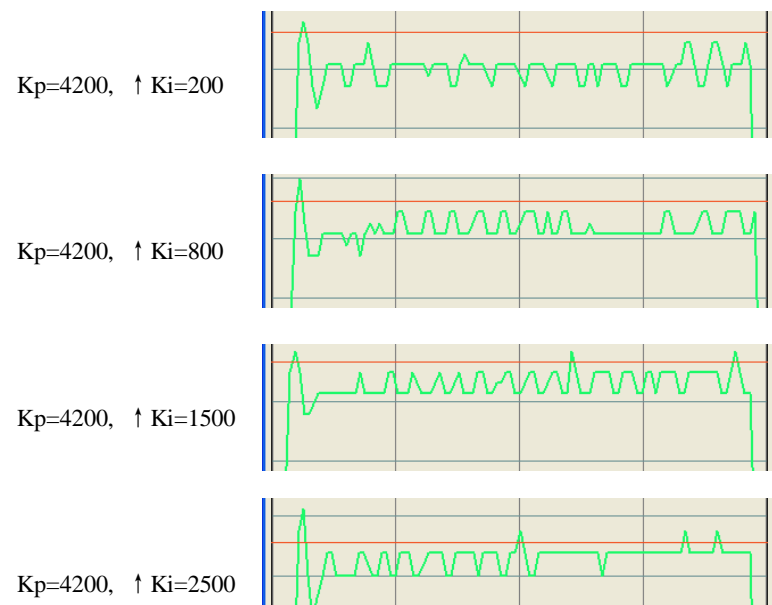

Figure 6-24: Current loop tuning with Kp=4200 and increasing Ki

### Velocity and Position Loop Tuning

Before trying to manage the velocity and position loop parameters (**Vp**, **Vi**, **Kp**, **Kp**, **Kaff**, see page 25), connect the system as figure 6-19. Then set self-test motion parameter and select the display curve in digital scope as figure 6-25, figure 26. **TraceTime** affects the display length of the curve. Here we select 720ms.

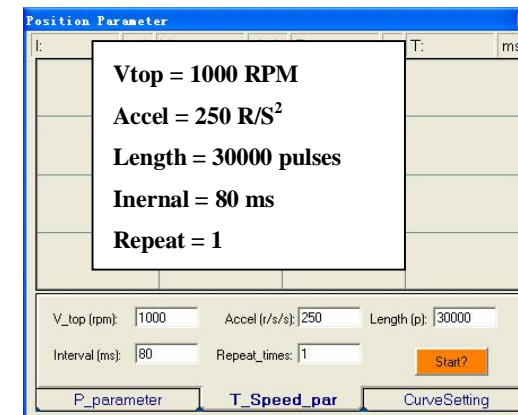

Figure 6-25: Self-test motion settings for the tuning

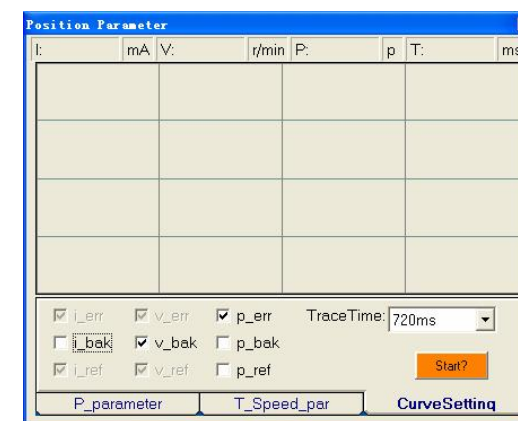

Figure 6-26: Digital Scope settings for the tuning

Our purpose is to get the highest system stiffness but lowest motor noise. However, sometimes we need to trade off between them because high loop gain leads to big overshoot even vibration. In this example, we start with small loop gain and then back off, at the time when the motor noise begins. The **Kaff** (application feed-forward gain) will be increased to further reduce the position following error if necessary. The tuning procedure is shown as follows:

- ① Small **Vp/Kp/Kaff**   ② **Vp**↑, **Vp**↓   ③ **Kp**↑, **Kp**↓   ④ **Kaff**↑

**Step 1:** Set **Vp** = 90, **Vi** = 0, **Kp** = 300, **Kaff** = 0, **Kd** = 500, **Encoder line** = 4000. Please hit the “**Enter**” key in the keyboard and click **Option->SaveToDrive** after changing the parameter. The initial value for the tuning is depending on supply voltage, motor and reflected load inertia. The above settings may not suitable for your system. Please adjust them according to different symptom as follows:

- I Decrease **Vp/Kp** if the motor generates big noise.
- I Increase **Vp/Kp** if the drive’s red LED blinks (Protection mode).

**Tip:** Giving an external torque by rotating the motor shaft (or moving the load) manually is good way to check whether the **Vp** and **Vd** are suitable or not. If it is hard to rotate/move and the motor generates big noise, you should lower down **Vp/Kp**. If it is easy to rotate/move and even the drive goes into protection mode (the red LED blinks), you should increase **Vp/Kp**.



Figure 6-27: Observe the motor noise/vibration when increasing loop gain

**Step 2:** Increase **Vp** until motor noise/vibration begins. Then back off. To activate the noise/vibration, sometimes you need to give a disturbance to the load by either clicking the **Start** button or trying to push/pull the load. In this example, we give **Vp** 120, 150, 200, 250 and find that the noise/vibration at **Vp**=250 can be accepted. So we stop increasing **Vp**. Figure 6-28 shows the velocity (The green curve) and position following error (The blue curve). And we can see the current position following error is 1074 at the top of the digital scope.

**Tip:** The digital scope displays actual velocity (the green curve) and position following error (The blue curve) as shown in figure 6-28. It is the result of the trapezoidal velocity test by clicking **Start** button. Click the button once again to hold on the curves (The button caption is “**Start**”). Otherwise the scope will be always updated (The button is “**Stop**”). The user can put the mouse (cursor) on the curve to check the curve point value at the top status bar.

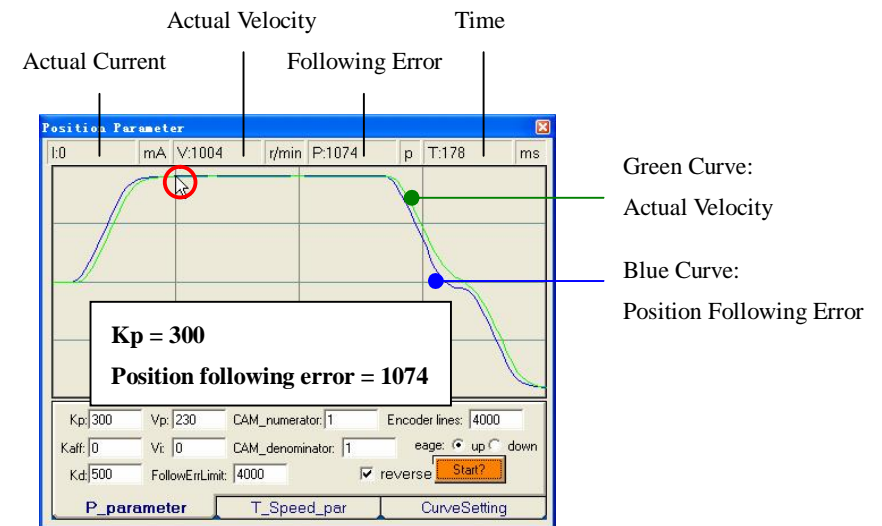

Figure 6-28: Digital scope for position/velocity loop tuning

**Step 3:** Increase **Kp** to maximize the system stiffness until motor noise/vibration begins, following the same way as **Vp**. See figure 6-29, 6-30, 6-31 and 6-32. The motor shaft or load is stiff enough at standstill when we increase **Kp** to 1800 and the motor noise/vibration can be accepted.

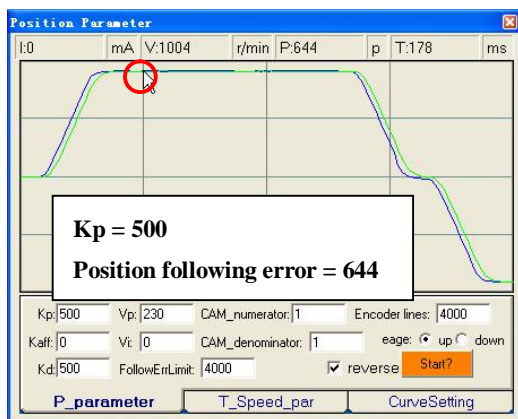

Figure 6-29: Increase Kp to 500 for quick response

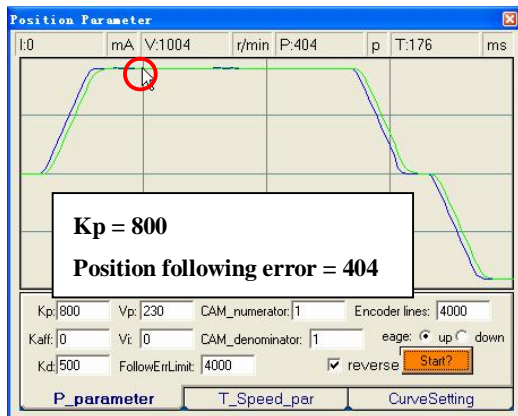

Figure 6-30: Increase Kp to 800 for quick response

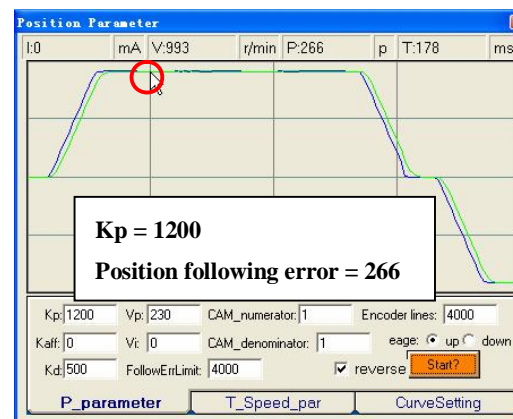

Figure 6-31: Increase Kp to 1200 for quick response

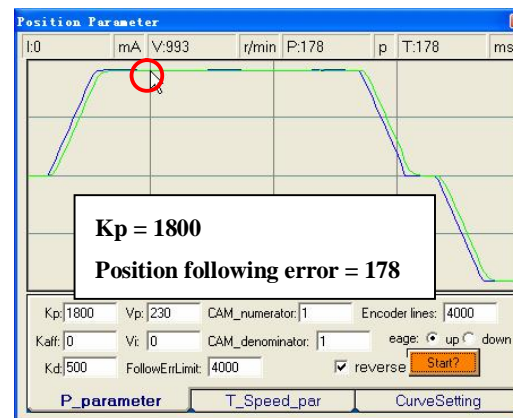

Figure 6-32: Increase Kp to 1800 for quick response

Now the system has been basically tuned. In the following step, the user can increase **Kaff** to further reduce the position following error if necessary.

**Step 4:** Increase **Kaff** to 5000 and 10000. The position following error reduces to 132 and 86, respectively. See figure 6-33 and 6-34.

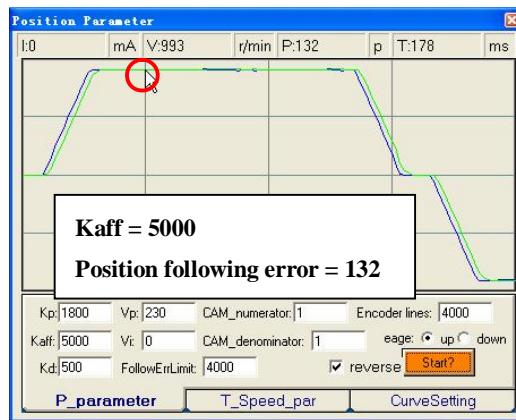

Figure 6-33: Increase Kaff to 5000 for quick response

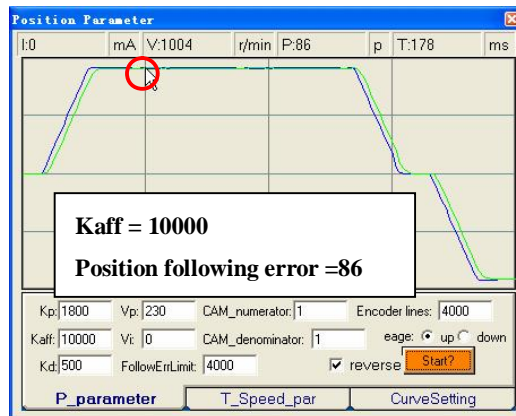

Figure 6-34: Increase Kaff to 10000 for quick response

Remember that tuning the servo is to get satisfying performances, getting the best performances of the servo is a time consuming work. So if the servo performance can meet your application requirements, then the easier tuning way the better. Just like if the performances of the products can meet your application requirements, then the cheaper the better.

## 7. Using Tips

### Sequence Chart of Control Signals

In order to avoid some fault operations and deviations, PUL, DIR and EN should abide by some rules, shown as the following figure:

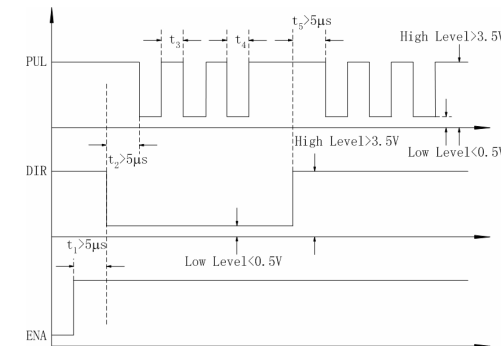

Figure 7-1: Sequence chart of control signals

#### Notes:

- a)  $t_1$ : EN must be ahead of DIR by at least  $5\mu s$ . Usually, ENA is NC (not connected). See **Connections** section for more information.
- b)  $t_2$ : DIR must be ahead of PUL effective edge by at least  $5\mu s$  to ensure correct direction.
- c)  $t_3$ : Pulse width not less than 2.5s;
- d)  $t_4$ : Low level width not less than 2.5s.

### Protection Functions

To improve reliability, the driver incorporates some built-in protection functions. The DCS810S uses one RED LED to indicate what protection has been activated. The periodic time of RED is 5 s (seconds), and how many times the RED turns on indicates what protection has been activated. Because only one protection can be

displayed by RED LED, so the driver will decide what error to display according to their priorities. See the following **Protection Indications** table for displaying priorities.

### Over-current Protection

Protection will be activated when continuous current exceeds 20A, and RED LED will turn on once within each periodic time (5 s).

### Over-voltage Protection

When power supply voltage exceeds  $84.5 \pm 1.5$  VDC, protection will be activated and RED LED will turn on twice within each periodic time (5 s).

### Phase Error Protection

When power-up, motor power lines wrong connected and encoder feedback signals A/B phases wrong connected will activate this protection. If the motor power line(s) drop(s) from the drive will also cause this protection. RED LED will turn on four times within each periodic time (5 s).

**Note:** When power-up, the motor shaft needs to be rotated 1 revolution to activate this protection if the motor power lines are not connected.

### Encoder Error Protection

No encoder feedback signals or wrong encoder feedback signals will activate this protection. RED LED will turn on five times within each periodic time (5 s).

**Note:** When power-up, the motor shaft needs to be stalled or rotated several revolutions to activate this protection if the motor encoder wire(s) not connected.





### Position Following Error Protection

When position following error reaches Position Following Error Limit parameter setting in the driver, this protection will be activated. RED LED will turn on seven

times within each periodic time (5 s).

**Attention:** Since there is no protection against power leads (+, -) reversal, it is critical to make sure that power supply leads correctly connected to driver. Otherwise, the driver will be damaged instantly.

### Protection Indications

Priority	Time(s) of ON	Sequence wave of RED LED	Description
1 <sup>st</sup>	1		Over-current protection
2 <sup>nd</sup>	2		Over-voltage protection
3 <sup>rd</sup>	4		Phase error protection
4 <sup>th</sup>	5		Encoder error protection
5 <sup>th</sup>	7		Position following error protection

### Changing Default Motor Direction

The DCS810S will turn the motor in the CW direction when the direction input is “high” (logical “1”). If instead CCW is preferred, then:

- 1) Reverse the “motor +” and “motor -” leads.
- 2) Reverse the encoder “Channel A” and “Channel B” leads.

### Maximum Pulse Input Frequency

Maximum Pulse Input Frequency is the highest frequency that the driver can accept. To convert this frequency to RPM, use the following formula:



$$RPM(\max) = \frac{(\text{Max Pulse Input Frequency}) \times 60}{(\text{Encoder Line Count}) \times 4} \times \frac{\text{CAM\_numerator}}{\text{CAM\_denominator}}$$

## Save data to a file

The **ProTuner** offers a tool to save parameter to a file. It is very useful when building machines with the same motors and other components. Select **Option->Archives**, the archives window will appear as figure 7-2. To save the current parameter to a file, type in the path and file name in the edit box and then click 'ToDisk' button. See figure 7-2 for more detail.

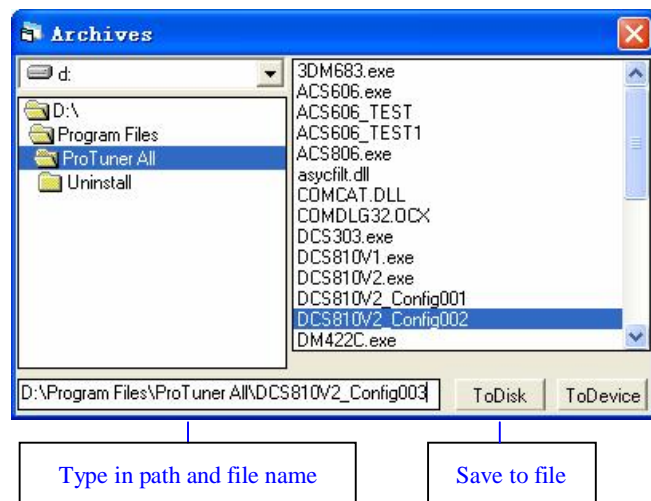

Figure 7-2: Save parameter to a file

## Load data from file to Drive

When communication between the **ProTuner** and the ACS806 is established, you can open a configuration file then download the data from the file to the drive. See figure 7-3 for more detail.

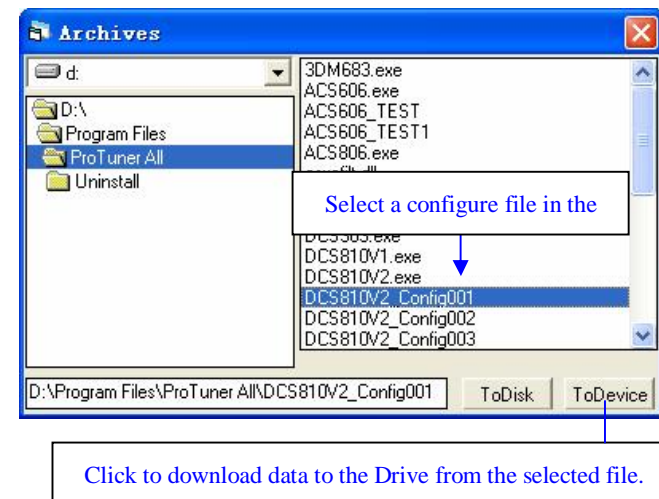

Figure 4: Download data to the drive





## APPENDIX

### TWELVE MONTH LIMITED WARRANTY

Leadshine Technology Co., Ltd. warrants its products against defects in materials and workmanship for a period of 12 months from shipping date. During the warranty period, Leadshine will either, at its option, repair or replace products which proved to be defective.

### EXCLUSIONS

The above warranty shall not apply to defects resulting from: improper or inadequate handling by customer; improper or inadequate customer wiring; unauthorized modification or misuse; or operation beyond the electrical specifications of the product and/or operation beyond environmental specifications for the product.

### OBTAINING WARRANTY SERVICE

To obtain warranty service, a returned material authorization number (RMA) must be obtained from customer service at e-mail: [tech@leadshine.com](mailto:tech@leadshine.com) before returning product for service. Customer shall prepay shipping charges for products returned to Leadshine for warranty service, and Leadshine shall pay for return of products to customer.

### WARRANTY LIMITATIONS

Leadshine makes no other warranty, either expressed or implied, with respect to the product. Leadshine specifically disclaims the implied warranties of merchantability and fitness for a particular purpose. Some jurisdictions do not allow limitations on how long and implied warranty lasts, so the above limitation or exclusion may not apply to you. However, any implied warranty of merchantability or fitness is limited



to the 12-month duration of this written warranty.

### SHIPPING FAILED PRODUCT

If your product should fail during the warranty period, e-mail customer service at [tech@leadshine.com](mailto:tech@leadshine.com) to obtain a returned material authorization number (RMA) before returning product for service. Please include a written description of the problem along with contact name and address. Send failed product to distributor in your area or: Leadshine Technology Co., Ltd. Floor 3, Block 2, Tianan Industrial Park, Nanshan Dist, Shenzhen, China. Also enclose information regarding the circumstances prior to product failure.



## Contact Us

### China Headquarters

**Address:** 3/F, Block 2, Nanyou Tianan Industrial Park, Nanshan District Shenzhen, China

**Web:** <http://www.leadshine.com>

### Sales Hot Line:

**Tel:** 86-755-2643 4369 (for All)

86-755-2641-7674 (for Asia, Australia, Africa areas)

86-755-2640-9254 (for Europe, America areas)

**Fax:** 86-755-2640-2718

**Email:** [sales@leadshine.com](mailto:sales@leadshine.com).

### Technical Support:

**Tel:** 86 755-2641-8447 and 86-755-2647-1129

**Fax:** 86-755-2640-2718

**Email:** [tech@leadshine.com](mailto:tech@leadshine.com) and [vic@leadshine.com](mailto:vic@leadshine.com).

### Leadshine U.S.A

**Address:** 25 Mauchly, Suite 318 Irvine, California 92618

**Tel:** 1-949-608-7270

**Fax:** 1-949-608-7298

**Web:** <http://www.leadshineUSA.com>

**Email:** [sales@leadshineUSA.com](mailto:sales@leadshineUSA.com) and [support@leadshineUSA.com](mailto:support@leadshineUSA.com).

### Leadshine Hong Kong

**Address:** Rm 3, 9/F, Block E, Wah Lok Industrial Center, 31-41 Shan Mei St., Fo Tan, Shatin, Hong Kong

**Tel:** 852-2952-9114

**Fax:** 852-2952-9395

**Email:** [hk\\_sales@leadshine.com](mailto:hk_sales@leadshine.com).